

## 印刷要求:

- 1 封面封底 157g 铜版纸覆哑膜彩打，内部纸 80g 双胶纸黑白打印，正反面打印。
- 2 装订方式:页码大于或等于 60 页需用胶装，小于 60 页使用骑马钉钉装。
- 3 A5 纸张尺寸印制。
- 4 图面及字体印刷清晰、无偏移、无毛边、不起边、油墨不脱落。
- 5 字体颜色为 PANTONE BLACK C，无边框，底色为白色。
- 6 符合 RoHS 要求。
- 7 最后一页（底部带 logo）放到封底最外面，内部正文页不放此页。

*注：本页为印刷要求，打印时需删除本页*

# LIVOLTEK

## User Manual

### Energy Storage Battery

Type: BLF-B51100



BLF-B51100.R110.V1.0



# Contents

1. About This Manual.....	1
1.1 Products Covered by This Manual.....	1
1.2 Target Group .....	1
1.3 Symbols Used .....	1
1.4 Storage of the Manual.....	2
2. Safety.....	2
2.1 Important Safety Instructions.....	2
2.2 Response to Emergency Situations.....	3
2.2.1 Leaking Batteries.....	3
2.2.2 Wet Batteries or Damaged Batteries.....	3
2.2.3 Fire.....	4
2.2.4 Advice for Firefighters.....	4
2.3 Handling and Storage Precautions .....	4
2.4 Limitation of Liability.....	4
3. Scope of Delivery .....	6
4. Product Description.....	7
5. Mounting .....	10
5.1 Environment Requirements.....	10
5.2 Tools .....	11
5.3 Angle and Space Requirements .....	12
5.3.1 Angle requirement.....	12
5.3.2 Space requirement for All-in-one .....	13
5.3.3 Space requirement for expansion.....	13
5.4 Mounting the Battery.....	14

- 5.4.1 Unpack and Check for Transport Damage ..... 14
- 5.4.2 Pre-installation check..... 14
- 5.4.3 Procedure for All-in-one Application ..... 14
- 5.4.4 Procedure for Expansion Application ..... 15
- 6. Electrical Connection..... 18
  - 6.1 Overview of the Connection Area..... 18
  - 6.2 Battery Power Connection..... 19
  - 6.3 BMS Communication Connection..... 20
  - 6.4 Parallel Connection of Multi-batteries ..... 21
- 7. Operating of the Battery ..... 23
  - 7.1 LED Indicator..... 23
  - 7.2 Turn On/Off the Battery ..... 23
- 8. Technical Data ..... 24

# 1. About This Manual

## 1.1 Products Covered by This Manual



Li-ion Battery: BLF-B51100 energy storage system.

## 1.2 Target Group

This manual is intended for a qualified electrician. Any electrical installation and maintenance on the battery must be performed by qualified electricians in compliance with standards, wiring rules or requirements of local grid authorities or bodies.

## 1.3 Symbols Used

The following types of safety precautions and general information symbols are used in this manual. These important instructions must be followed during installation, operation and maintenance of the battery.

Symbol	Description
 <b>DANGER</b>	Indicates a hazard with a high level of risk that, if not avoided, will result in death or serious injury.
 <b>WARNING</b>	Indicates a hazard with a medium level of risk that, if not avoided, could result in death or serious injury.
 <b>CAUTION</b>	Indicates a hazard with a low level of risk that, if not avoided, could result in minor or moderate injury.
<b>NOTICE</b>	Indicates a situation that, if not avoided, could result in equipment or property damage.

## 1.4 Storage of the Manual

Please keep the manual properly and operate in strict accordance with all safety and operating instructions in this manual. The information in this manual is subject to change without notice. Please check [www.LIVOLTEK.com](http://www.LIVOLTEK.com) for more information.

## 2. Safety

The manual describes the installation, commissioning, maintenance of the battery. Please read it carefully before operating. To prevent personal injury and property damage and to ensure long-term operation of the product, please read and follow all the instructions and cautions on the battery and this user manual during installation, operation or maintenance at all times.

### 2.1 Important Safety Instructions

#### **DANGER**

Danger to life from electric shock.

- Before performing any work on the battery, make sure the battery is power off and the DC isolator is disconnected.
- Do not short connect the DC connectors of the battery, which may cause electric shock to personnel and damage to the product.
- Do not touch DC connectors of the battery.
- If an error occurs, contact your local distributor or qualified electricians.

#### **WARNING**

- Only authorized service personnel are allowed to install the battery or perform servicing and maintenance.
- The power should be disconnected before attempting any maintenance or cleaning or working to the battery.

#### **NOTICE**

- Do not open the battery or change any components without authorization,

otherwise the warranty commitment for the battery will be invalid.

- Appropriate methods must be adopted to protect battery from electrostatic discharge; any damage caused by ESD is not warranted by the manufacturer.

## 2.2 Response to Emergency Situations

### 2.2.1 Leaking Batteries

- If the battery leaks electrolyte which is corrosive, avoid contact with the leaking liquid or gas. Direct contact may lead to skin irritation or chemical burns. If one is exposed to the leaked substance, do these actions:
- **General Advice:** Immediate medical attention is required. Show the safety data sheet (SDS) to the doctor in attendance.
- **Eye Contact:** Rinse thoroughly with plenty of water for at least 15 minutes and consult a physician if feel uncomfortable.
- **Skin Contact:** Take off contaminated clothing and shoes immediately. Wash off with plenty of water for at least 15 minutes and consult a physician if feel uncomfortable.
- **Ingestion:** Do not induce vomiting. Never give anything by mouth to an unconscious person. Call a physician or Poison Control Center immediately.
- **Inhalation:** Move victim into fresh air. If breathing is difficult, give oxygen. Do not use mouth to mouth resuscitation if victim ingested or inhaled the substance. If not breathing, give artificial respiration and consult a physician immediately.
- **Protecting of First-aiders:** Ensure that medical personnel are aware of the substance involved. Take precautions to protect themselves and prevent spread of contamination.

### 2.2.2 Wet Batteries or Damaged Batteries

- If the battery is wet or submerged in water, do not try to access it.
- If the battery seems to be damaged, they are not fit for use and may pose a danger to people or properties.
- Please pack the battery in its original container, and then return it to your



distributor

### **2.2.3 Fire**

The battery may catch fire when it is put into fire. In case of a fire, please make sure that a dry chemical, carbon dioxide or alcohol-resistant foam extinguisher is nearby. Do not use a solid water stream as it may scatter or spread fire.

### **2.2.4 Advice for Firefighters**

- In any fire, wear self-contained breathing apparatus (MSHA/NIOSH approved or equivalent) and full protective gear.
- Fight fire from a safe distance, with adequate cover.
- Prevent fire extinguishing water from contaminating surface water or the ground water system.

## **2.3 Handling and Storage Precautions**

- Handling is performed in a well ventilated place.
- Wear suitable protective equipment.
- Avoid contact with skin and eyes.
- Keep away from heat/sparks/open flames/ hot surfaces.
- Take precautionary measures against static discharges.
- Keep containers tightly closed.
- Keep containers in a dry, cool and well-ventilated place.
- Keep away from heat/sparks/open flames/ hot surfaces.
- Store away from incompatible materials and foodstuff containers.







## **2.4 Limitation of Liability**

- Any product damage or property loss caused by the following conditions LIVOLTEK does not assume any direct or indirect liability.
- Product modified, design changed or parts replaced without LIVOLTEK authorization;

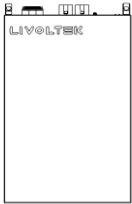
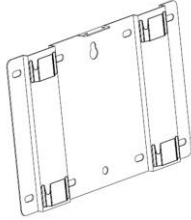
- Changes, or attempted repairs and erasing of series number or seals by non LIVOLTEK technician;
- System design and installation are not in compliance with standards and regulations;
- Failure to comply with the local safety regulations;
- The Product has been improperly stored in distributor's or end user's premises;
- Transport damage (including painting scratch caused by movement inside packaging during shipping). A claim should be made directly to shipping or insurance company as soon as the container/packaging is unloaded and such damage is identified;
- Failure to follow any/all of the user manual, the installation guide and the maintenance regulations;
- Improper use or misuse of the device;
- Insufficient ventilation of the device;
- The maintenance procedures relating to the product have not been followed to an acceptable standard;
- Force majeure (violent or stormy weather, lightning, overvoltage, fire etc.)
- Damages caused by any external factors.

### 3. Scope of Delivery

#### Battery Package

			
A: Battery	B: Wall-Mounting Bracket	C: Screws for Bracket	D: RJ45 CAN terminal resistor
1 pcs	1 pcs	4 pcs	1 pcs
			
Power cable-to inverter	F:Double RJ45 Communication cable	G:User Manual	
1 pair	1 pcs	1 pcs	

*NOTE: Accessories for different applications may be different.*

## 4. Product Description

Thank you for choosing the LIVOLTEK battery. The BLF-B51100 battery is a Low Voltage Lithium-ion battery. It is designed for energy storage system. It must only be connected with an officially tested inverter (Hybrid or Off-Grid series).







Figure 1. View of the BLF-B51100 Lithium Battery

Position	Definition
A	DC Breaker
B	Connection Area Cover Battery+, Battery-, Communication
C	Nameplate Label: Clearly identify the product, including the SN, technical data, certifications, etc.







**⚠ CAUTION**

If the battery is not used or not installed for 3 months ~~a long time~~, it is recommended to measure the voltage and charge it before use for better maintenance.

**Icons on the Nameplate**

Symbol	Explanation
	Caution, Risk of Danger
	Caution, Risk of Electric Shock
	CE marking The battery complies with the requirements of the applicable EU directives.
	Read the user manual before using
	WEEE Mark. The scrapped battery cannot be put into the garbage can and must be professionally recycled.

## Icons on the warning label

Symbol	Designation
	<p>Refer to the Operating Manual before using</p>
	<p>Caution, Risk of Danger</p>
	<p>Caution, Risk of Electric Shock</p>
	<p>Keep the battery away from open flame or ignition sources.</p>
	<p>Keep the battery away from children.</p>
	<p>Do not short circuit the battery.</p>
	<p>WEEE Mark. The scrapped battery cannot be put into the garbage can and must be professionally recycled.</p>

## 5. Mounting

### 5.1 Environment Requirements

Install the Battery System on the surface with sufficient bearing capacity and flatness, wooden surface is prohibited. Increase the bearing capacity and flatness of the surface by laying the foundation, adding bearing plates and so on.



- Keep children away from the battery.
- The optimal ambient temperature for the battery is 15~35°C.
- Avoid exposing the equipment to direct sunlight or rain.
- Install the equipment away from heat/cold source.
- Do not install the equipment in the place where the temperature changes extremely.
- Install the equipment away from strong interferences to ensure its regular work.
- Do not install the equipment in places prone to accumulate water.
- Do not put inflammable or explosive matters near the equipment.

## 5.2 Tools

These tools are required to install the battery.

		
Electric Hammer	Screw Driver	Pencil
		
Tap measure	Multi-meter	Utility knife

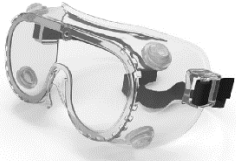
It is recommended to wear the following safety gear when dealing with the battery system.

		
Insulated Gloves	Safety Goggle	Safety shoes



## 5.3 Angle and Space Requirements

### 5.3.1 Angle requirement



Never install the Battery horizontally, or with a forward tilt or with a backward tilt or even with upside down. Install the battery upright or at a maximum back tilt of **15 degrees** to facilitate heat dissipation.

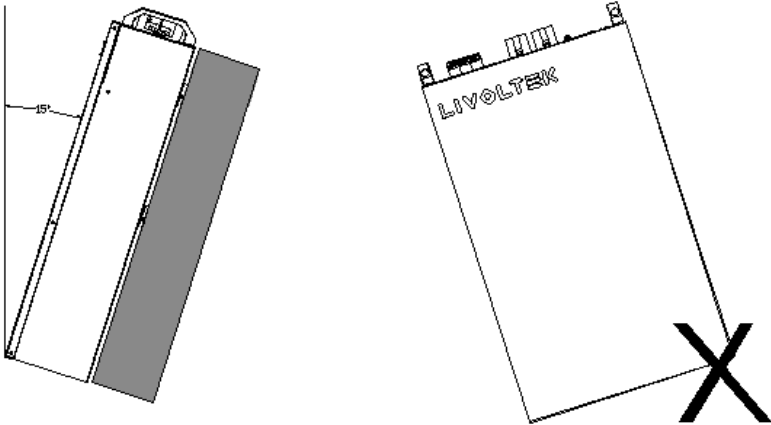

This battery is indoor version and can be only installed in an indoor location. The space around batteries recommended refer to the figure below

### 5.3.2 Space requirement for the battery



	Position	Min. size/mm
	Left	100
	Right	100
	Top	200 (Inverter not included)
	Bottom	50
	Front	300

### 5.3.3 Space requirement for expansion



The horizontal space between 2 adjacent batteries should not exceed 100 mm, otherwise the length of parallel power cables will be insufficient.

	Position	Min. size(mm)
	Top	200(inverter not included)
	Bottom	50
	Front	300
	Left of left battery	100
	Right of right battery	100

## **5.4 Mounting the Battery**

### **5.4.1 Unpack and Check for Transport Damage**

Unpacking the battery package and make sure the battery is intact during transportation. If there are some visible damages, such as cracks, or missing, please contact your dealer immediately.

### **5.4.2 Pre-installation check**

- After opening the package, check if the package items are complete. If there is any part missing, please contact your dealer immediately.
- Check and confirm the battery is power off and DC breaker is off before any further step.
- Turn on the DC breaker, when the battery self-test successfully, its green light turns on. If the red light is on, please contact your dealer immediately.
- Then go on to next step after turning off the battery.

### **5.4.3 Procedure for Inverter**

For more detailed information and installation steps, please refer to the Inverter user manual & quick installation guide.

## 5.4.4 Procedure for Expansion Application

---

### STEP 1: Anchor Battery Bracket

Plan and measure the distance between system components and determine whether cables will be routed into the system from the top, bottom, or side of the enclosure before installation.

Make sure the wall is strong enough to withstand the weight of battery.

Take out the Wall-mounting Bracket (battery-bracket) and locate the appropriate drilling holes, then mark it with a marker pen.

Drill holes with electric hammer, make sure the holes are deep enough (at least 65mm) to support the battery.

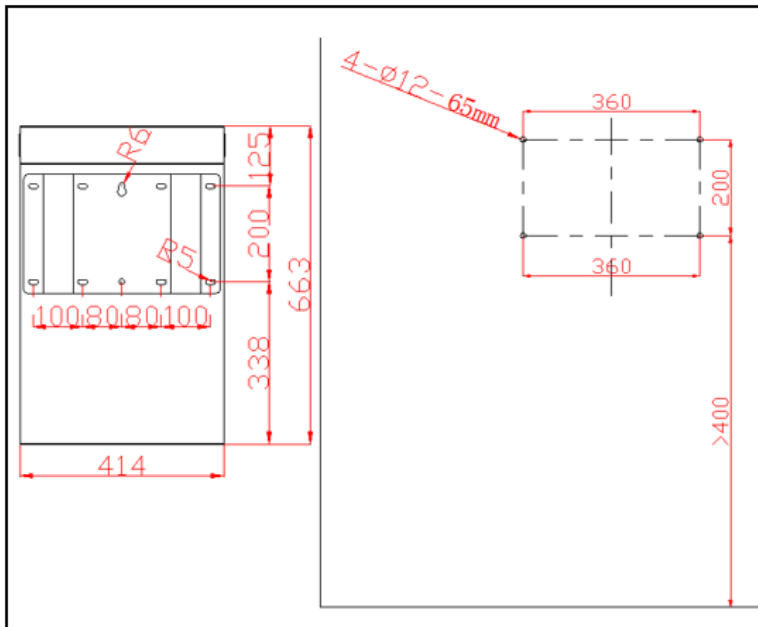

Product back dimension drawing

---

## STEP 2: Screw the bracket on the wall

- Use expansion bolts or correct wall fixings to attach the mounting bracket on the wall tightly.

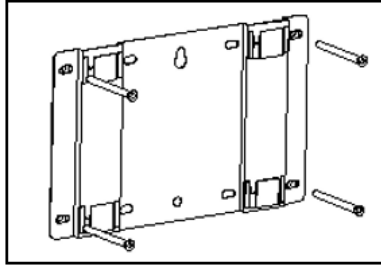

---

## STEP 3: Mount the Battery to the Bracket

- Lift and hang the battery to the battery-bracket and ensure that the two mounting ears perfectly engage with the battery-bracket.

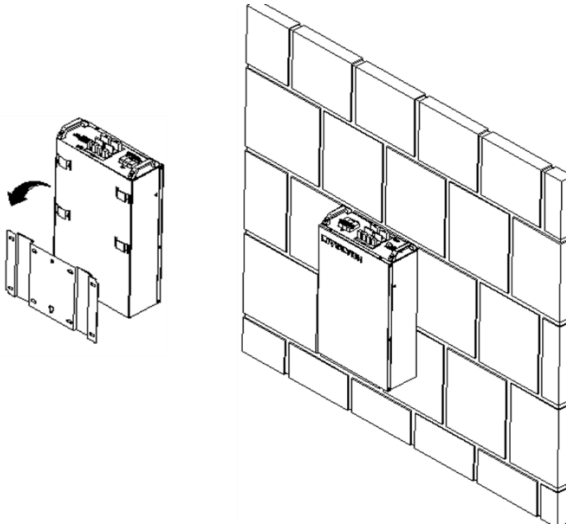

---

#### STEP 4: Electrical connections

- Thread the power and communication cable to the designated ports. (refer to Chapter 6.1).
- Connect power and communication cable to Inverter. More detailed information and installation steps of Inverter, please refer to the Inverter user manual & quick installation guide.

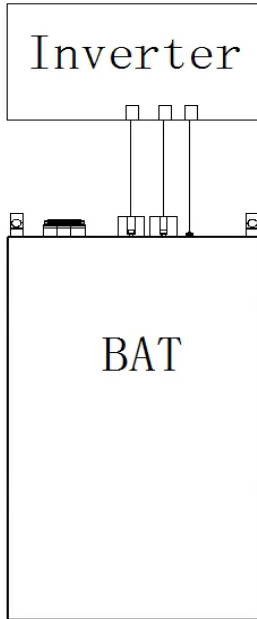

# 6. Electrical Connection

## 6.1 Overview of the Connection Area

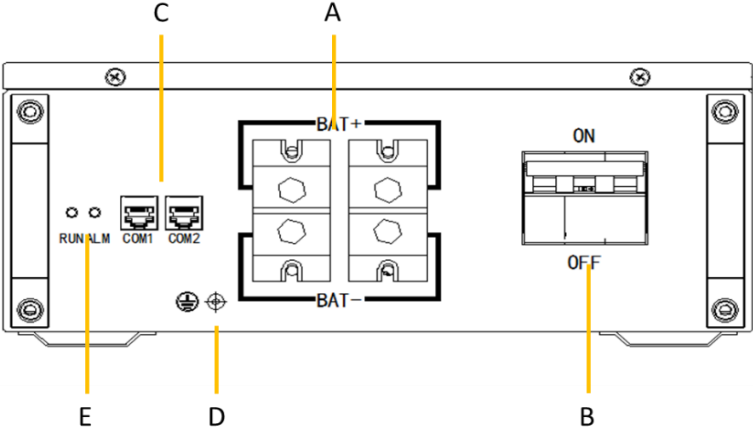

Position	Definition
A	Battery Power Ports
B	DC Breaker
C	BMS Communication Ports
D	Ground Port
E	LED Indicator

## 6.2 Battery Power Connection

### Battery connection diagram

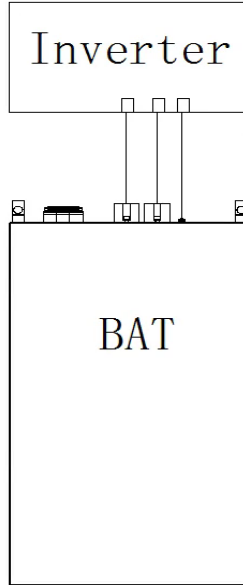

Red /Blue solid line: Positive / Negative power cable

Black dotted line: CAN communication cable.

### Procedure:

---

Before connecting the power cables, make sure the DC breaker of the battery is disconnected.

---

#### STEP 1:

Install the OT terminals ends of power cable to the battery.

#### STEP 2:

Plug the other ends of power cables into inverter.

---



### 6.3 BMS Communication Connection

Please check whether the BMS communication cable in the accessory box is appropriate for the battery. If you are not sure for that, please confirm with your vendor.

#### Procedure:

---

##### STEP 1:

Please insert the RJ45 connector of the communication cable into the COM1 port of battery.

---

##### STEP 2:

Please insert the other end of the cable in the corresponding port of inverter.

---

##### STEP 3:

Plug the RJ45 CAN terminal resistor into the COM2 port of the battery.(No difference between COM1 and COM2)

---

#### MS Connector Pin Definition:

1	Orange/white	BMS_CAN_H
2	Orange	BMS_CAN_L
3	Green/white	BMS_485_A
4	Blue	GND
5	Blue/white	BMS_485_B
6	Green	NC
7	Brown/white	NC
8	Brown	NC

## 6.4 Parallel Connection of Multi-batteries

Expandability: Up to 5 units of BLF-B51100 batteries can be parallel connected in one system.

### Parallel Connection Diagram (Expansion Application)

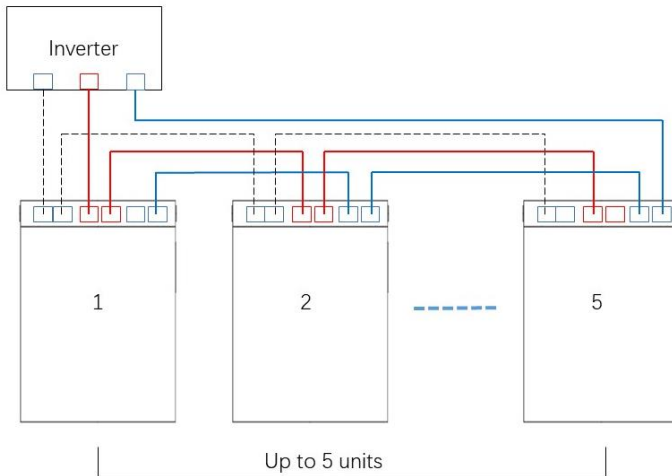

Red /Blue solid line: Positive / Negative power cable

Black dotted line: CAN communication cable.

#### Procedure:

---

#### STEP 1:

- Connect all the positive terminals (BAT+) of power ports of each battery by parallel power cable.
  - Connect all the negative terminals (BAT-) of power ports of each battery by parallel power cable.
  - Connect the positive terminal (BAT+) of the nearest battery from the inverter to the positive terminal (BAT+) of the inverter by power cable to inverter.
-

---

Two batteries system: Connect the negative terminal (BAT-) of the nearest battery from the inverter to the negative terminal (BAT-) of the inverter by power cable to inverter.

At least 3 batteries system :Connect the negative terminal (BAT-) of the farthest battery from the inverter to the negative terminal (BAT-) of the inverter by negative power cable to inverter(which must be harnessed on site ).

---

### STEP 2:

- Connect the BMS ports of each battery. The COM2 should be connected to the COM1.
  - Then connect the COM1 port of the nearest battery from the inverter to the corresponding port of inverter.
- 

### STEP 3:

Plug the RJ45 terminal resistor into the COM2 port of the farthest battery from the inverter.

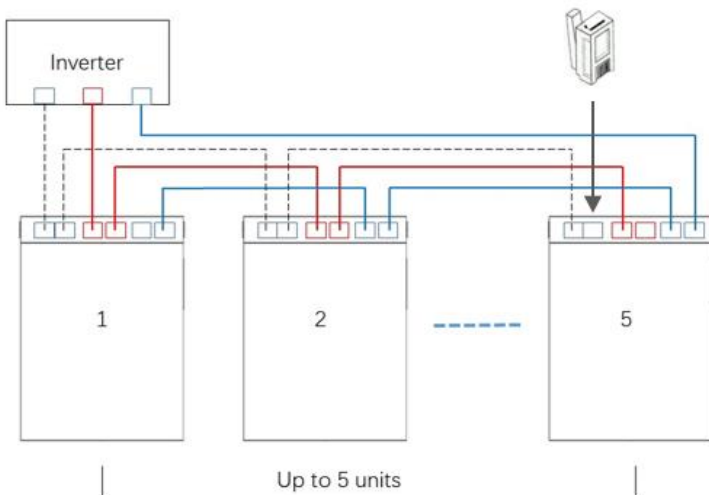

# 7. Operating of the Battery

## 7.1 LED Indicator

The LED indicates the operating status of the battery.

LED	Explanation
Green	Green light indicates the battery works well.
Red	Fault occurs in the battery. SOC $\leq$ 8%

When red light is on for more than 12 hours indicates fault occurs in the battery, please contact technical support for help.

## 7.2 Turn On/Off the Battery

- When turn on the battery, turn on the DC breaker;
- When turn off the battery, disconnect the DC breaker.

## 8. Technical Data

<b>Electrical Data</b>	<b>BLF-B51100</b>
Cell Type	LFP
Total Energy	5.12 kWh
Usable Energy	4.6 kWh
Depth of Discharge	90%
Nominal Capacity	100 Ah
Nominal Voltage	51.2 V
Operating Voltage Range	40-58.4 V
Nominal Power	5.12 kW
Max. Continuous Charge/Discharge Power	4.1kW / 5.12kW
Rated Charge/Discharge	50A/50A
Max. Continuous Charge/Discharge	80A/100A
Operating Temperature	0~55°C charge / -20~55°C discharge
Communication	CAN / RS485
Max. Parallel Number	5 Units
Mounting information	Wall-mounted
Ingress Protection	IP21
Operating Humidity	5%-95%
Operating Altitude	<4000m
Cooling Type	Natural

Design Life	>10 years
Dimension(W*H*D)	335*585*135.5 mm
Weight	44 kg

**LIVOLTEK<sup>®</sup>**

 1418-35 Moganshan Road, Hangzhou, 310011, China

 [info@livoltek.com](mailto:info@livoltek.com)

 [www.livoltek.com](http://www.livoltek.com)