



User Manual

Residential Energy Storage System

BLF51 Series(IP65)



BLF51-5.R320 V2.3

CONTENTS

1.	About This Manual	1
1.1	Products Covered by This Manual.....	1
1.2	Target Group	1
1.3	Symbols Used.....	1
1.4	Storage of the Manual	1
2.	Safety	2
2.1	Important Safety Instructions.....	2
2.2	Response to Emergency Situations	3
2.3	Limitation of Liability	4
3.	Scope of Delivery	5
4.	Product Description	7
5.	Mounting	9
5.1	Environment Requirements	9
5.2	Angle and Space Requirements	10
5.3	Mounting the Battery.....	11
6	Electrical Connection	15
6.1	Overview of the Connection Area	15
6.2	Battery Power Connection	16
6.3	BMS Communication Connection	17
6.4	Parallel Connection of Multi-batteries	18
7	Operating of the Battery	20
7.1	LED Indicator.....	20
7.2	Turn On/Off the Battery	20
8	Technical Data	21

1. About This Manual

1.1 Products Covered by This Manual

BLF51 Series Li-ion battery:



BLF51-5.R320

1.2 Target Group

This manual is intended for a qualified electrician. Any electrical installation and maintenance on the battery must be performed by qualified electricians in compliance with standards, wiring rules or requirements of local grid authorities or bodies.

1.3 Symbols Used

The following types of safety precautions and general information symbols are used in this manual. These important instructions must be followed during installation, operation and maintenance of the battery.

 DANGER	Indicates a hazard with a high level of risk that will result in death or serious injury.
 WARNING	Indicates a hazard with a medium level of risk that can result in death or serious injury.
 CAUTION	Indicates a hazard with a low level of risk that can result in minor or moderate injury.
NOTICE	Indicates a situation which, if not avoided, can result in property damage.

1.4 Storage of the Manual

Please keep the manual properly and operate in strict accordance with all safety and operating instructions in this manual. The information in this manual is subject to change without notice. Please check www.LIVOLTEK.com for more information.

2. Safety

The manual describes the installation, commissioning, maintenance of the battery. Please read it carefully before operating. To prevent personal injury and property damage and to ensure long- term operation of the product, please read and follow all the instructions and cautions on the battery and this user manual during installation, operation or maintenance at all times.

2.1 Important Safety Instructions

DANGER

Danger to life from electric shock.

- Before performing any work on the battery, make sure the battery is power off and the DC isolator is disconnected.
 - Do not short connect the DC connectors of the battery, which may cause electric shock to personnel and damage to the product.
 - Do not touch DC connectors of the battery.
 - If an error occurs, contact your local distributor or qualified electricians.
-

WARNING

- Only authorized service personnel are allowed to install the battery or perform servicing and maintenance.
 - The power should be disconnected before attempting any maintenance or cleaning or working to the battery.
-

NOTICE

- Do not open the battery or change any components without authorization, otherwise the warranty commitment for the battery will be invalid.
 - Appropriate methods must be adopted to protect battery from electrostatic discharge; any damage caused by ESD is not warranted by the manufacturer.
-

2.2 Response to Emergency Situations

➤ Leaking Batteries

If the battery leaks electrolyte which is corrosive, avoid contact with the leaking liquid or gas. Direct contact may lead to skin irritation or chemical burns. If one is exposed to the leaked substance, do these actions:

- **Accidental inhalation of harmful substances:** Evacuate people from the contaminated area, and seek medical attention immediately.
- **Eye contact:** Rinse eyes with flowing water for 15 minutes, and seek medical attention immediately.
- **Dermal contact:** Wash the affected area thoroughly with soap and water, and seek medical attention immediately.
- **Ingestion:** Induce vomiting, and seek medical attention immediately.

➤ Wet Batteries or Damaged Batteries

- If the battery is wet or submerged in water, do not try to access it.
- If the battery seems to be damaged, they are not fit for use and may pose a danger to people or property.
- Please pack the battery in its original container, and then return it to your distributor

➤ Fire







- If a fire breaks out where the battery is installed, do these actions:
- Extinguish the fire before the battery catches fire;
- If the battery has caught fire, do not try to extinguish the fire.
- Evacuate people immediately.

2.3 Limitation of Liability

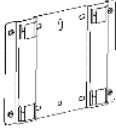
Any product damage or property loss caused by the following conditions LIVOLTEK does not assume any direct or indirect liability.

- Product modified, design changed or parts replaced without LIVOLTEK authorization;
- Changes, or attempted repairs and erasing of series number or seals by non LIVOLTEK technician;
- System design and installation are not in compliance with standards and regulations;
- Failure to comply with the local safety regulations;
- The Product has been improperly stored in distributor's or end user's premises;
- Transport damage (including painting scratch caused by movement inside packaging during shipping). A claim should be made directly to shipping or insurance company as soon as the container/packaging is unloaded and such damage is identified;
- Failure to follow any/all of the user manual, the installation guide and the maintenance regulations;
- Improper use or misuse of the device;
- Insufficient ventilation of the device;
- The maintenance procedures relating to the product have not been followed to an acceptable standard;
- Force majeure (violent or stormy weather, lightning, overvoltage, fire etc.)
- Damages caused by any external factors.

3. Scope of Delivery

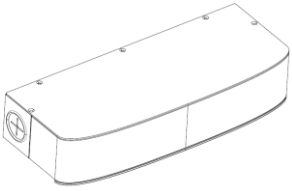
			
A	B	C	D
			
E	F	G	H
			
I			

Item	QTY	Designation
A	1	Battery
B	1	Battery-Bracket
C	4	Screws for Fixing Mounting Bracket
D	1	User Manual
E	1 pair	Parallel Power cable- positive & negative , 4AWG ;

F	1	Communication cable with waterproof terminals
G	1	MSDS report documents
H	1	RJ45 CAN resistor with waterproof terminal
I	1	Connection area cover kit

NOTICE

Accessories for different applications may be different.

4. Product Description

Thank you for choosing the LIVOLTEK battery. The **BLF51 Series** battery is a series of Low Voltage Lithium-ion battery. It is designed for residential and commercial energy storage system. It must only be connected with **LIVOLTEK** inverter (Hybrid or Off-Grid series).

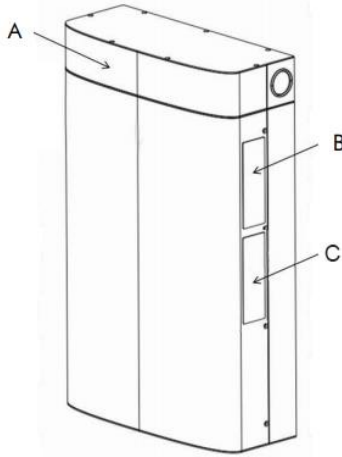





Figure 1. View of the BLF51 Series Lithium Battery

Position	Designation
A	Connection Area Cover For All-in-one application with hybrid inverter, the cover is not included.
B	Nameplate Label: Clearly identify the product, including the SN, technical data, certifications, etc.
C	Warning label (Optional)

⚠ CAUTION

If the battery is not used or not installed for a long time, it is recommended to measure the voltage and charge it before use for better maintenance.

Icons on the Nameplate

Symbol	Explanation
	Caution, Risk of Danger
	Caution, Risk of Electric Shock
	Refer to the Operating Manual
	WEEE Mark. This inverter should not be disposed as ordinary waste.

5. Mounting

5.1 Environment Requirements

NOTICE

Install the Battery System on the surface with sufficient bearing capacity and flatness, **wooden surface is prohibited** . Increase the bearing capacity and flatness of the surface by laying the foundation, adding bearing plates and so on.

- **Keep children away from the battery.**
- The optimal ambient temperature for the battery is 15~35°C.
- Avoid exposing the battery to direct sunlight or rain.
- Install the battery away from heat/cold source.
- Do not install the battery in the place where the temperature changes extremely.
- Install the battery away from strong interferences to ensure its regular work.
- Do not install the battery in places prone to accumulate water.
- Do not put inflammable or explosive matters near the battery.

CAUTION

Installation and maintenance personnel must operate according to applicable federal, state and local regulations as well as the industry standard. The product installation personnel shall wear safety gears, etc. in order to avoid short circuit and personal injury.

5.2 Angle and Space Requirements

CAUTION

Never install the Battery horizontally, or with a forward tilt or with a backward tilt or even with upside down. Install the battery upright or at a maximum back tilt of 15 degrees to facilitate heat dissipation.

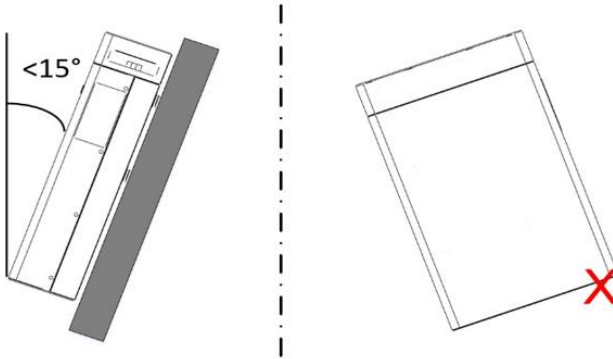

This battery is indoor version and can be only installed in an indoor location. The space around batteries recommended refer to the figure below

CAUTION

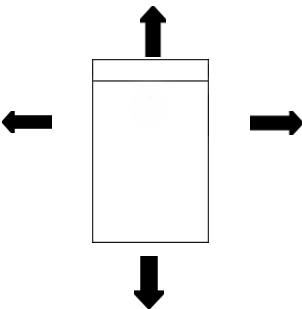

Space Requirement

Position	Min.size
Left	100mm
Right	100mm
Top	200mm (inverter not included)
Bottom	50mm
Front	300mm

5.3 Mounting the Battery

5.3.1 Unpacking and Check for Transport Damage

Unpacking the battery package and make sure the battery is intact during transportation. If there are some visible damages, such as cracks, or missing, please contact your dealer immediately.

5.3.2 Procedure for All-in-one Application

The battery bracket, power cables, and BMS cables are along with the inverter in the inverter package. For more detailed information and installation steps, please refer to the inverter user manual.

5.3.3 Procedure for Expansion Application

STEP 1: Anchor Battery Bracket

- Plan and measure the distance between system components and determine whether cables will be routed into the system from the top, bottom, or side of the enclosure before installation.
- Make sure the wall is strong enough to withstand the weight of battery.
- Take out the Wall-mounting Bracket (battery-bracket) and locate the appropriate drilling holes, then mark it with a marker pen.
- Drill holes with driller, make sure the holes are deep enough (at least 60mm) to support the battery.

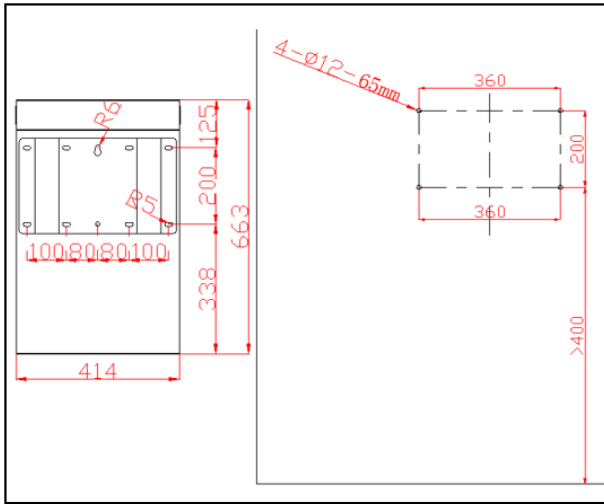

STEP 2: Screw the bracket on the wall

- Use expansion bolts or correct wall fixings to attach the mounting bracket on the wall tightly

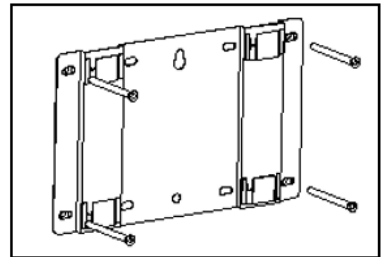

STEP 3: Mount the Battery to the Bracket

- Lift and hang the battery to the battery-bracket and ensure that the four mounting ears perfectly engage with the battery -bracket.

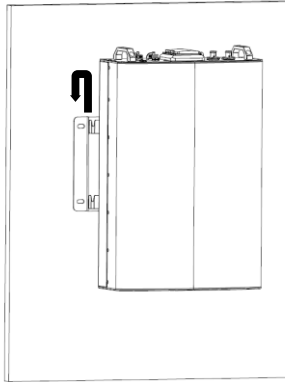

STEP 4: Install the Back cover of Connection Area Cover kit

- Install the Back cover of Connection Area Cover to the battery with 4 M8*4 screws, then lock the screws.

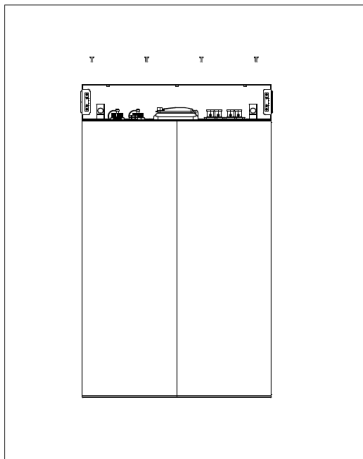

STEP 5: Electrical connections

- Cut a cross through the both silicone rubber sleeves of with a sharp tool (scissors or knife) on both sides.
- Thread the power and communication cable through the cross and connect them to the designated ports. (refer to in Chapter 6).

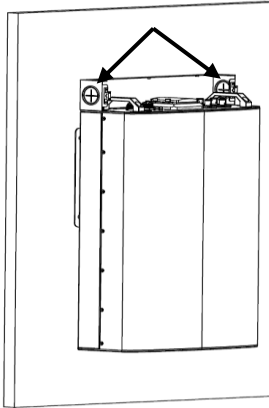

STEP 6: Install the Connection Area Cover

- After the electrical connections is finished, put on the upper cover of connection area and lock the screws and then push in the front cover.

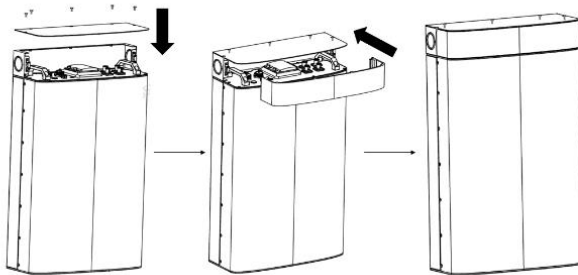

6 Electrical Connection

6.1 Overview of the Connection Area

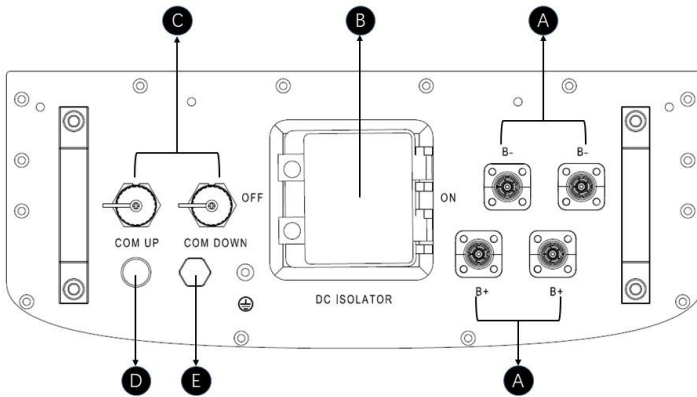

Position	Designation
A	Battery Power Ports
B	DC Isolator
C	Communication ports ,COM DOWN and COM UP
D	LED Indicator
E	Grounding Port

6.2 Battery Power Connection

Battery connection diagram

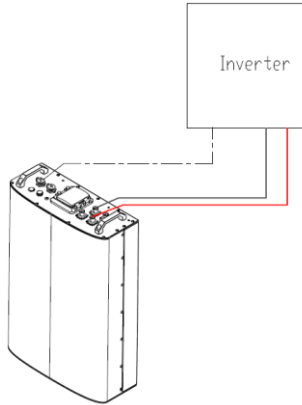

Procedure:

⚠ CAUTION

Before connecting the power cable, make sure the DC isolator of the battery is disconnected.

STEP 1:

- Plug the connectors of power cables into battery power ports, make sure the polarities are correct.

STEP 2:

- Plug the other ends of power cables into inverter. make sure the polarities are correct.
-

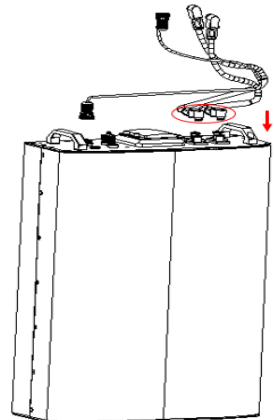

6.3 BMS Communication Connection

Please check whether the BMS communication cable in the accessory box is appropriate for the battery. If you are not sure for that, please confirm with your vendor.

Procedure:

STEP 1:

- Please insert the RJ45 connector into the COM UP port of battery.
-

STEP 2:

- Please insert the other end of the cable in the corresponding port of inverter.
-

STEP 3:

- Please clockwise rotate the locking nut of the waterproof terminal of communication cable to the BMS port & the corresponding port of inverter.
-

BMS Connector Pin Definition:

	1	Orange/white	BMS_CAN_H
	2	Orange	BMS_CAN_L
	3	Green/white	BMS_485_A
	4	Blue	GND
	5	Blue/white	BMS_485_B
	6	Green	NC
	7	Brown/white	NC
	8	Brown	NC

6.4 Parallel Connection of Multi-batteries

Expandability: Up to 5 units of BLF51 Series batteries can be parallel connected in one system.

Parallel Connection Diagram

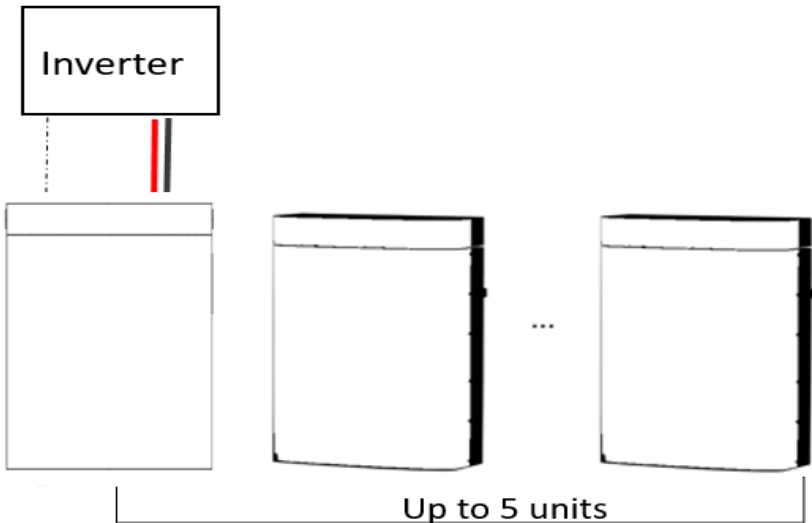

Procedure:

STEP 1:

- Connect all the positive terminals of power ports of each battery.
- Connect all the negative terminals of power ports of each battery.
- Connect the power ports to inverter.

STEP 2:

- Connect the BMS ports of each battery. The COM DOWN should be connected to the COM UP.
 - Then connect the COM UP port of the nearest battery from the inverter to the corresponding port of inverter.
-

STEP 3:

- Plug the RJ45 CAN resistor with waterproof terminal into the COM DOWN port of the farthest battery from the inverter.
- Then clockwise rotate the locking nut on the body to fasten the RJ45 waterproof terminal.

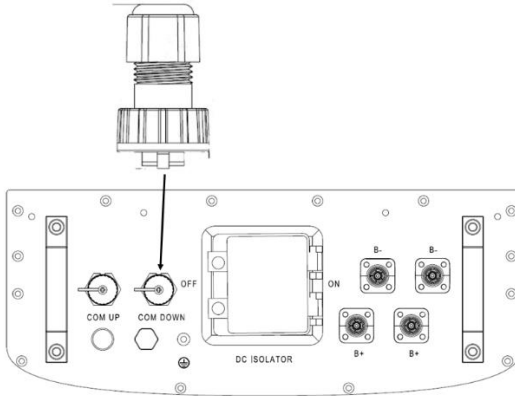

NOTICE

The RJ45 CAN resistor with waterproof terminal is recommended to be used when multiple batteries have been connected in parallel.

7 Operating of the Battery

7.1 LED Indicator

The LED indicates the operating state of the battery.

LED indicator	Status	Description
Green	on	Normal status
Red	on	Fault occurs in the battery

7.2 Turn On/Off the Battery

- If you want to TURN ON the battery, connect the DC isolator directly.
- If you want to TURN OFF the battery, disconnect the DC isolator directly.



Closing the DC ISOLATOR means turning on the battery.

8 Technical Data

Electrical Data	BLF51-5
Cell Type	LFP
Total Energy	5kWh
Depth of Discharge	100%
Usable Energy	5 kWh
Nominal Voltage	51.2 V
Nominal Capacity	100 Ah
Operating Voltage Range	40-58.4 V
Max. Charge/Discharge Current@25°C	85A/100A
Scalability	Up to 5 modules/25kWh
General Data	
Mounting information	Wall-mounted / Ground-mounted
Communication	CAN / RS485
Operating Temperature	0~50°C charge / -10~55°C discharge
Dimension(W*H*D)	415*685*178 mm
Weight	55 kg
IP Protection Type	IP65

Warranty Card Registration

LIVOLTEK

Dear customer, thank you for choosing LIVOLTEK product.
For registering product warranty, please prepare everything ready
and register on

<https://www.livolttek.com/registration.html>.

Product Information	
Product Type	
Product S/N	
Installation date	
Installation Company	
Personal Information	
Your name	
Your contact number	
Your Email address	
Your home address	

*Warranties should be registered within 36 months of installation, however it is recommended that they are registered no more than 6 weeks following the successful installation and commissioning of the Product where possible, thanks for your cooperation.



Contacts:

Hangzhou Livoltek Power Co., Ltd

Address: 1418-35 Moganshan Road, Hangzhou, 310011, China

Tel: +86-571-28330320

Fax: +86-571-28020357

Email: info@livoltek.com

Web: www.livoltek.com

LIVOLTEK®

 1418-35 Moganshan Road, Hangzhou, 310011, China

 info@livoltek.com  www.livoltek.com